

KSV NIMA

Langmuir and Langmuir-Blodgett Deposition Troughs
Modules and Accessories

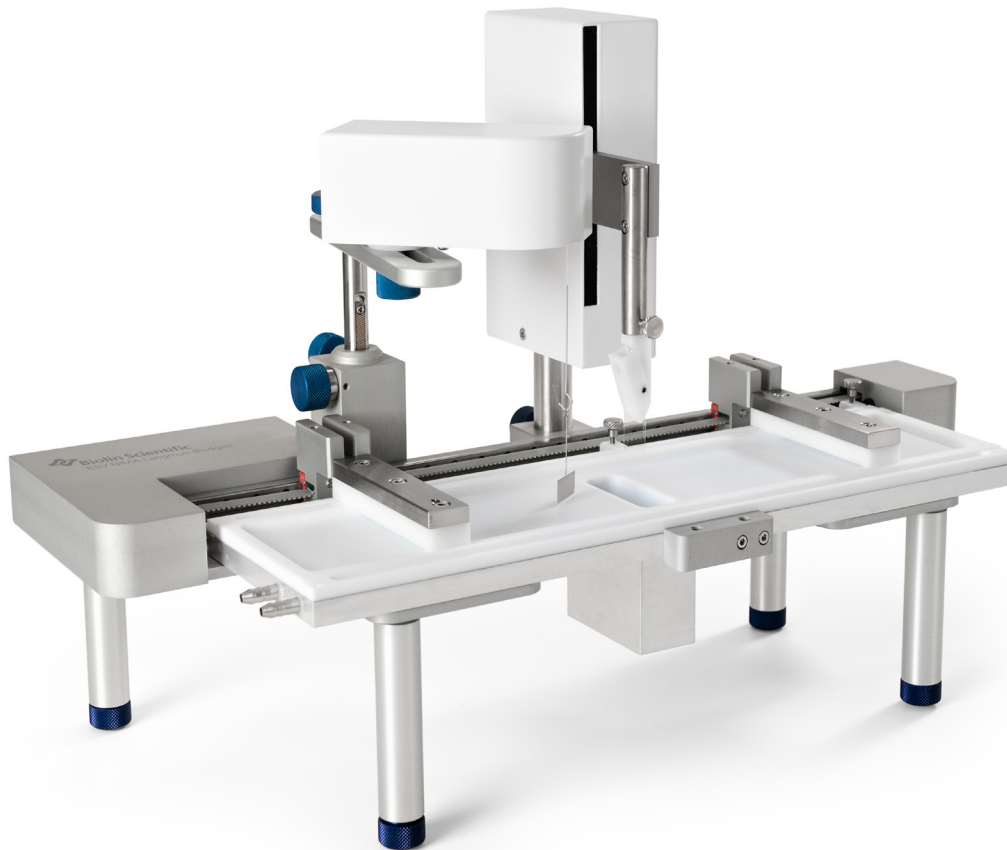

Modules

All modules listed below are standard equipment for all KSV NIMA Troughs.

- 1 – Frame
- 2 – Barriers
- 3 – Trough top
- 4 – Surface pressure sensor
- 5 – Dipping mechanism (LB option)
- 6 – Interface Unit

For [Langmuir experiments](#), a frame, a set of barriers, a Langmuir rough top (or alternatively a Langmuir-Blodgett trough top or a microscopy trough top) and a surface pressure sensor are required.

For [Langmuir-Blodgett deposition](#), a frame, a set of barriers, a Langmuir-Blodgett trough top (or alternatively a Langmuir trough top if only performing Langmuir-Schaefer deposition), a surface pressure sensor and a dipping mechanism are required.

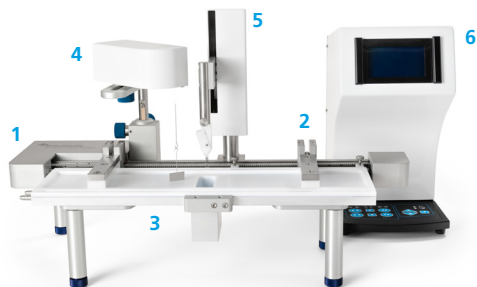

Each module can be easily removed, added or replaced by others with different specifications to match your experiment requirements.

1. Frames

When choosing a Langmuir, Langmuir-Blodgett or Microscopy Trough, the frame size will determine the future capabilities of your system and possible upgrade opportunities. The frame is the module which supports and connects all other modules to the computer via the KSV NIMA Interface Unit. The following frames are available:

Standard frame (Small and Medium size troughs)

A frame suitable for small to medium trough top surface areas, for low to medium subphase volumes and for coating small to medium size samples. Langmuir trough tops and Langmuir-Blodgett Deposition trough tops are available in several sizes. On specialty trough tops, the standard frame supports medium liquid-liquid LB trough top, small upright microscopy trough top and an inverted medium trough top. Finally, it is the default frame for ribbon barrier trough tops.

Large Frame (Large trough)

A frame suitable for a large trough top surface area as well as deposition on large samples. This frame can fit a Langmuir trough top or a Langmuir-Blodgett Deposition trough top. Note: the Small, Medium, Liquid-liquid, High compression and Ribbon barrier trough tops can also be used with this frame.

High compression frame

A frame intended to maximise the compression ratio (long but narrow) and get better results when characterising thin films (e.g. Surface potential, Brewster Angle Microscopy). It is also the frame chosen to measure with the KSV NIMA Interfacial Shear Rheometer. The same frame is used for high-compression liquid-liquid Langmuir trough top. Note: the Small and Medium trough tops can also be used with this frame.

Alternate Frame

A frame equipped with a two compartment trough, two surface pressure sensors and two pairs of barriers. Used mainly for alternating depositions of two Langmuir films.

Roll-to-Roll Frame

Frame designed specifically for roll-to-roll LB deposition for large coated areas. Can also be used all other trough tops besides the Alternate.

2. Barriers

Delrin barriers (POM)

Ref. KN 0040, KN 0043, KN 0045, KN 0046

Barriers are used to compress your monolayer. They are positioned on a barrier drive that is controlled by the software. All frames come with a barrier drive and a pair of Delrin barriers. Delrin barriers are hydrophilic to prevent leakage under the barrier during compression.

Teflon barriers (PTFE)

Ref. KN 0041, KN 0044, KN 0047

Hydrophobic Teflon barriers are available as an option for situations where extended chemical resistance is needed.

Type of barriers	Delrin barriers	Teflon barriers
Regular barriers for XS, S, M, HC and Alternate systems	KN 0040	KN 0041
Large barriers for L systems	KN 0043	KN 0044
Liquid-liquid barriers*	KN 0045	-

* Liquid-liquid barriers are always fitted to the trough top. In case barriers are bought separately, the trough top needs to be returned to our production workshop for optimal fitting.

Ribbon Barrier (PTFE coated ribbon)

Ref. KN 0065

Durable hydrophobic glass fiber ribbon to be used with a KSV NIMA Ribbon barrier trough top. Set of 5 pieces. For Langmuir and Langmuir-Blodgett Ribbon Barrier trough tops, see dedicated section below.

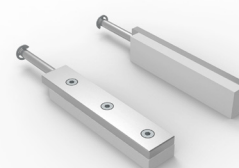

Regular Delrin barriers
Ref. KN 0040

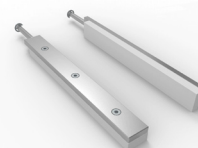

Large Delrin barriers
Ref. KN 0043

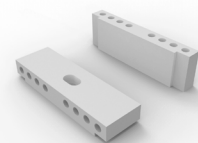

Liquid-liquid Delrin barriers
Ref. KN 0045



Ribbon barrier (5 in a set)
Ref. KN 0065

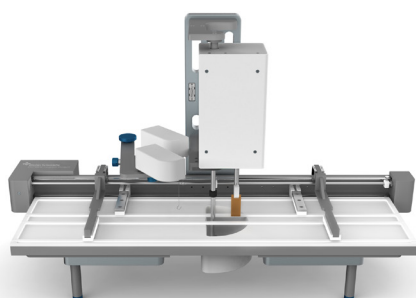

Alternate-Layer Deposition Trough
Ref. KN 2006

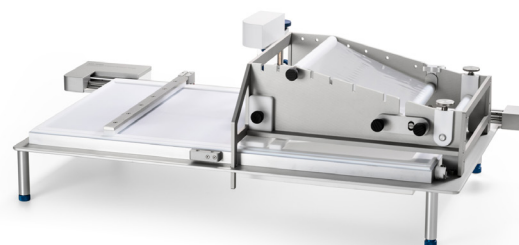

Roll-to-Roll
Ref. KN 2008

3. Trough Tops

Trough tops come in different sizes and with different specifications. Depending on your frame, you can select from:

Langmuir trough tops

A Langmuir trough top is a hydrophobic (PTFE) shallow chamber designed to hold a liquid phase.

Langmuir-Blodgett deposition trough tops

A Langmuir-Blodgett deposition trough top is similar to a Langmuir trough top with the addition of a dipping well in its centre. The well is necessary when conducting vertical deposition, as the sample needs to go through the film, below the liquid surface.

Microscopy trough top

• Upright microscopy

An upright microscopy trough top is a special type of Langmuir trough top designed for microscopic observation. A sapphire window is added in the trough top base allowing optical transmission down to a wavelength of 200 nm (suitable for visible light and UV).

• Inverted microscopy

The inverted microscopy trough top is very similar to the upright microscopy trough top. The only difference is that the sapphire window is replaced by a thin glass window mechanism designed specifically for inverted microscopy which allows for a very short working distance objective.

Ribbon Barrier trough top

• Langmuir Ribbon Barrier trough top | KN 0063

The Langmuir Ribbon Barrier trough top only differs from a conventional Langmuir trough top by its compression mechanism. A ribbon barrier is used instead of the conventional barriers for improved monolayer confinement at high surface pressure. It enables the study of highly packed Langmuir films. The most common application is the study of lung surfactant behaviour in alveoli. The Ribbon Barrier trough top comes with PTFE ribbon holders and 5 PTFE coated glass fibre ribbons.

• Langmuir-Blodgett Ribbon Barrier trough top | KN 0064

The Langmuir-Blodgett Ribbon Barrier trough top is a Langmuir Ribbon Barrier trough top with an added dipping, enabling deposition of the monolayer confined within the ribbon onto a solid sample.

Demonstrating KSV NIMA Trough flexibility

KSV NIMA Langmuir Trough Large equipped with a Medium Langmuir trough top

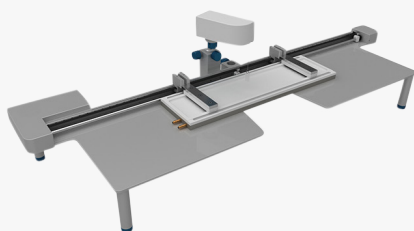

Most of KSV NIMA systems allow easy switch between modules including frames, trough tops, barriers and dipper. This ensures you get the most out of your system, no matter your needs and applications. Your KSV NIMA Trough is a safe long term investment.

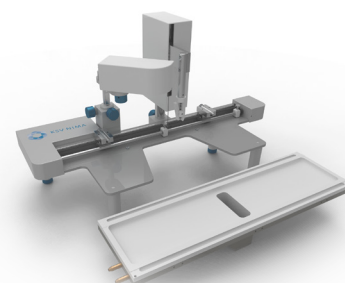

Langmuir-Blodgett trough top

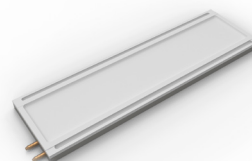

Langmuir trough top

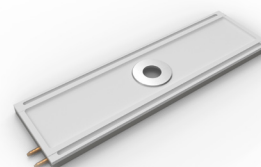

Microscopy trough top
(can be for upright and/or inverted microscopy, depending on the frame)

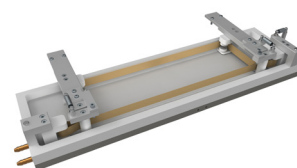

Langmuir Ribbon Barrier trough top
ref. KN 0063

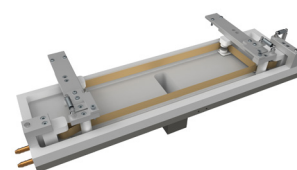

Langmuir-Blodgett Ribbon Barrier
trough top
ref. KN 0064

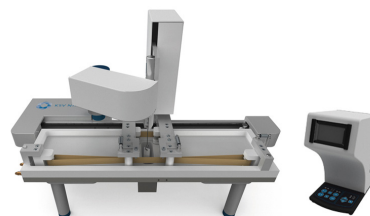

Complete Langmuir-Blodgett
Ribbon Barrier Trough ref. KN 2005

Full Frame/Trough Top Compability Chart

The table on the previous page shows the most common combinations of frame and trough tops. The trough tops are automatically associated with a frame of similar size. However, thanks to KSV NIMA easily exchangeable trough top system, many other combinations are possible. As a general rule, trough tops can fit on any larger frame. It means you can choose from a greater variety of trough top dimensions and features covering even more applications.

Frame	Langmuir Trough Top						Langmuir-Blodgett Trough Top					Uptight Microscopy Trough Top	Inverted Microscopy Trough Top
	S	M	L	L-L	HC	RB	S	M	L	L-L	RB	S	M
Standard	•	•	-	-	-	•	•	•	-	•	•	•	•
Large	•	•	•	•	•	•	•	•	•	•	•	•	•
HC/L-L	•	•	-	•	•	•	•	•	-	•	•	•	•
Alternate	•	•	•	•	•	•	-	-	-	-	-	•	•
R2R	•	•	•	•	•	•	•	•	•	•	•	•	•

• : compatible (note: choose compatible barriers)
 - : not compatible

HC: High compression
 L-L: Liquid-liquid

RB: Ribbon Barrier
 R2R: Roll-to-roll

4. Surface Pressure Sensor

The surface pressure is monitored by a highly sensitive balance measuring the force exerted on a Wilhelmy plate or a rod which is suspended across either the air-liquid or liquid-liquid interface. The surface pressure sensor has a measuring range from 0 up to 300 mN/m with a resolution of 0,03 µN/m. The surface pressure sensor is common to all KSV NIMA Troughs and can easily support either paper or Platinum Wilhelmy plates (see accessory list for all pressure sensor probes).

The Alternate troughs are equipped with a different dipping mechanism than the other troughs, enabling complex deposition sequences through two monolayers. You can find more information about it on our web site or by contacting your closest KSV NIMA representative.

The Roll-to-Roll LB Trough has a special roll system instead of a regular dipper, enabling the coating of particularly large areas. Please contact your nearest KSV NIMA representative for more information.

5. Dipping Mechanism

A dipping mechanism is a necessary piece of equipment for the controlled Langmuir-Blodgett (vertical) and Langmuir-Schaefer (horizontal) deposition on your samples. Langmuir-Blodgett Deposition Troughs are always shipped with a dipper.

For all troughs, the dipping mechanism can be purchased separately to upgrade a Langmuir Trough system to a Langmuir-Blodgett Deposition Trough (requires also a Langmuir-Blodgett deposition trough top, sold separately). A dipping mechanism can also be used for Langmuir-Schaefer deposition together with the horizontal dipping clamp (accessory KN 0006), even when using a Langmuir Trough or a Microscopy Trough (no need for a dipping well). Please note that the Large system requires the large dipping mechanism (longer stroke than the standard dipping mechanism used for Small/Medium/Liquid-liquid/High compression systems).







6. Interface Unit

The KSV NIMA Interface Unit is used with all KSV NIMA Langmuir and Langmuir-Blodgett Deposition Troughs as well as other instruments. It enables convenient control of the trough barriers, dipping mechanism and magnetic stirrer right next to the instrument (controlling is also possible from the computer). The Interface Unit features an easy to read digital display, spill-proof and intuitive touch pad, USB data connection to allow simple connection to all computers, pH-probe connector, temperature control (including probe) and magnetic stirrer control. It is also possible to attach an additional analogue voltage device, +/-10V, for special applications. In other words, the KSV NIMA Interface Unit is connecting all instrument modules and accessories with the computer and even with additional characterisation equipments such as the KSV NIMA SPOT (Surface Potential Sensor).

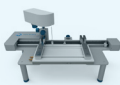
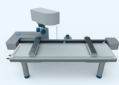
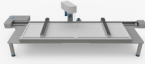
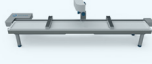
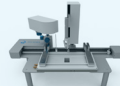
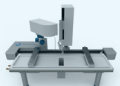
Snapshot of the most common KSV NIMA Troughs

The Troughs in the table below are complete systems, already equipped with the necessary modules for Langmuir, Langmuir-Blodgett deposition or microscopy applications. Additional modules and accessories for possible upgrade and replacements are described in the following pages.

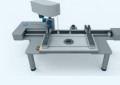
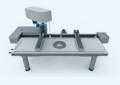
The modularity of KSV NIMA L & LB Troughs means many other combination are possible. Only the default configuration are shown below. Please contact your closest KSV NIMA representative to know more about the different possible combinations.

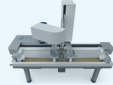
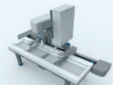
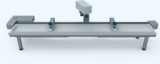
SMALL	MEDIUM	LARGE	HIGH COMPRESSION	ALTERNATE	ROLL-TO-ROLL
Langmuir Troughs					
 KN 1002	 KN 1003	 KN 1006	 KN 1005		
Langmuir-Blodgett Deposition Troughs (A = Alternate)					
 KN 2001	 KN 2002	 KN 2003		 A = KN 2006	 KN2008
Microscopy Troughs (U = upright, I = inverted)					
 U = KN 3001	 I = KN 3003				
Lite Troughs (L=Langmuir, LB=Langmuir-Blodgett)					
	 L=KN LITE 1003, LB=KN LITE 2002				
Ribbon Barrier Troughs (L = Langmuir, LB = Langmuir-Blodgett)					
	 L = KN 1007 LB = KN 2005				
Liquid-Liquid Troughs					
	 KN 2007		 KN 1004		
STANDARD FRAME		LARGE FRAME	HIGH COMPRESSION FRAME	ALTERNATE FRAME	

Accessories

1. Surface potential measurement

Surface Potential Sensor

Ref. KN 0001

The KSV NIMA Surface Potential Sensor is a compact and highly sensitive characterisation instrument that offers complementary data on the packing and orientation of surfactant molecules within the sampling region of a Langmuir film. The Surface Potential Sensor (SPOT) measures the potential difference above and below the film and is sensitive to the sum of all the individual dipole moments:

- Measuring head and electrode plate
- Separate stand with height adjustment
- Plug-and-Play function with the KSV NIMA Interface Unit and LB Software

The KSV NIMA SPOT is factory calibrated for quick and easy start up.



2. Environmental and sample control

Cabinets

Ref. CABI SMALL, ref. CABI LARGE

In situations where an ideal cleanroom environment is not available, a suitable alternative may be to house your instruments in one of our dust and draught exclusion cabinets.

KSV NIMA cabinets are made from an aluminium frame with clear acrylic glass panels on all sides including the doors at the front. There is no base to the cabinet, making it easier to house/un-house your instruments, should you so wish. The cabinets are equipped with connectors for water tubing and electric cables.

Cabinets come in two different sizes:

- L712 x W450 x H500 mm, for KSV NIMA Troughs XS, S and M (ref. CABI SMALL)
- L1200 x W700 x H830 mm, for KSV NIMA Troughs L, High compression (ISR) and Liquid-liquid (ref. CABI LARGE)

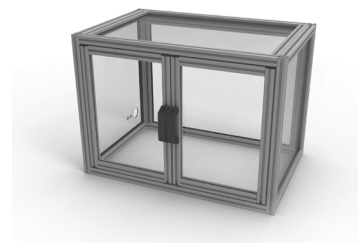

Active vibration isolation system

Ref. AVS-LARGE

The active vibration isolation system allows you to remove vibrations in order to improve the quality of your measurements. It enables you to eliminate disturbing vibrations caused by other instruments, air conditioning systems, buildings and constructions in a zone of seismic activity, cars and traffic in general. Specifications:

- Element dimensions: 636 x 130 x 111 mm
- Breadboard size (effective surface area): 100 x 600 x 60 mm
- Load capacity: 300 kg (150 kg per element)
- Isolation performance: min. 25 dB (94.4%) at 5 Hz, 35 dB (98.2%) beyond 10 Hz
- Manual load adjustment
- Analog diagnostic output (BNC)



pH probe

Ref. KN 0011

pH measuring probe. Note this requires the KSV NIMA Interface Unit.



Bath/Circulator Julabo CD200F

Ref. KN 102USB

A constant temperature bath/circulator, for sample liquid temperature regulation. Operated as LB software controlled and as stand-alone. Temperature range -20 to +150°C. Stability 0.03°C. Digital readout. USB communication. Includes 10 m rubber housing for waterbath connection. NOTE! KSV NIMA PTFE Troughs allow only constant use at maximum 60°C.



Temperature measurement probe

Ref. KN 0054

This temperature probe is already included with every KSV NIMA Trough. This is only for replacement and spare parts.

3. Subphase and samle handling

Injection port

Ref. KN 0016

This simple device is useful for investigations of the adsorption of molecular material to the air-water interface, perhaps while a compressed monolayer of a different material is being supported. The injected material could also be a solution that modifies the subphase properties, without penetrating the monolayer. The KSV NIMA injection port is compatible with all our Langmuir and Langmuir-Blodgett Deposition Troughs except the Alternates.

Subphase evaporation compensation tool

Ref. KN 0068

For automatic compensation of subphase evaporation. In long measurements or measurements done in elevated temperatures, subphase evaporation has a significant effect on the surface pressure reading. Evaporation also exposes the measurement to many other undesired risks such as monolayer leakages under the barriers. The subphase evaporation compensation tool monitors the surface level through buoyancy and automatically compensates any evaporated subphase liquid with a peristaltic pump. The compensation can work over 100 hours continuously. Controlled with the KSV NIMA LB software.

Magnetic stirrer

Ref. KN 0012

For continuous, gentle stirring of the trough subphase, KSV NIMA offer a magnetic stirring device. The stirring bar sits in the trough subphase and rotates around a point above the magnetic stirrer device. This may be particularly useful in conjunction with an injection port as it assists with the mixing of the injected material in the subphase, for example when the injected material modifies the subphase properties or interacts with the monolayer.

The PTFE coated stirring bar is very easy to clean so will not introduce contamination into your experiments. The thickness of the bar is small enough to prevent disturbance of the water surface. It is recommended that the rotation velocity be reduced to a very low setting during measurements of the Langmuir film properties. The stirring speed is directly adjustable from the KSV NIMA LB Software.

KSV NIMA magnetic stirrers do not cause any electromagnetic interference with the barrier motor control or with the sensitive surface pressure sensor electronics.

Syringe pump

Ref. KN 0067

For PC-controlled monolayer sample introduction. Enables superior dispensing accuracy compared to sample introduction manually by hand. Enables also steady sample introduction even with extremely low sample introduction rates. This is beneficial especially when using nanoparticles dispersed in a miscible solvent as they need to be deposited on the surface extremely carefully to avoid sample sedimentation into the subphase. Controlled with the KSV NIMA LB software. Dispensing resolution 0.1 μl .

Standalone aspirator pump

Ref. KN 0007

Electric suction pump for cleaning the surface of the subphase.

It comes with a container and only requires a power socket near by, making it extremely convenient to operate.



Temperature measurement probe

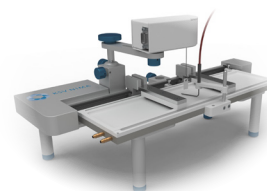

Easy placement in trough subphase (holder provided with every trough)

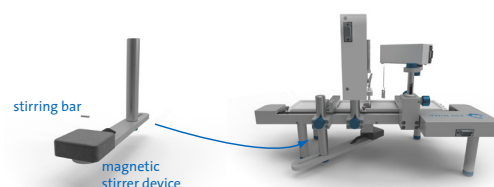
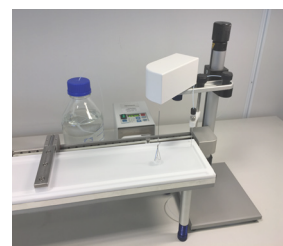

4. Horizontal deposition (Langmuir-Schaefer)

Vacuum pump based horizontal dipping clamp (Langmuir Schaefer holder)

Ref. KN 0006

To perform horizontal LS deposition on your Langmuir, Langmuir-Blodgett or Microscopy Trough, you will need a dipping mechanism and a Langmuir-Schaefer holder. The holder consists of a suction pump (not shown here) connected with flexible tubing to a sample holder rod. On the end of the sample holder is a soft rubber suction cup that creates a vacuum when brought into contact with a substrate. Two sizes of interchangeable suction cups are provided. The LS deposition kit is suitable for all KSV NIMA Troughs equipped with a dipping mechanism except the Alternates.

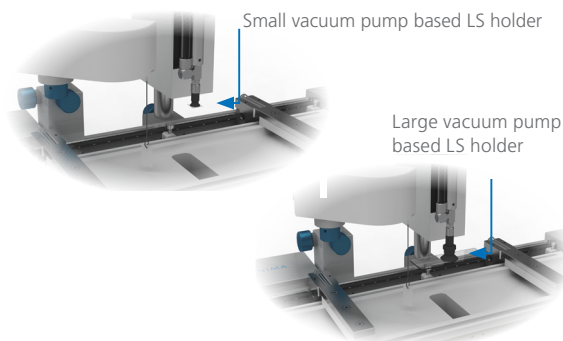

5. Pressure sensor probes

Paper Wilhelmy plates

Ref. KN 0005

Pre-cut paper Wilhelmy plates for surface pressure measurement. We use Whatman CHR1 chromatography paper (perimeter 20.6 mm). 100 pieces. Also includes 10 extension hooks.

- Napless, Class I (OOH) filter papers
- Acid cleaned with an ash content of less than 0.007 %
- Weight 80 gm/m²

Please note that a small quantity of pre-cut paper Wilhelmy plates are supplied free of charge with a KSV NIMA Langmuir and Langmuir-Blodgett Deposition Troughs, part of the Monolayer starter kit.

Platinum Wilhelmy Plates

Ref. KN 0002, ref. KN 0003, ref. KN 0057

As an alternative to the conventional chromatography paper Wilhelmy plate, a platinum Wilhelmy plate can be used as it can be repeatedly cleaned and reused. They come in three sizes:

- Large, perimeter 39.24 mm, height 10 mm (ref. KN 0002)
- Small, perimeter 20 mm, height 10 mm (ref. KN 0003)
- Liquid-liquid, perimeter 39.24 mm, height 7 mm (ref. KN 0057)

Please note most KSV NIMA Troughs come with a Large Platinum Wilhelmy plate as it is part of the Monolayer starter kit. In the case of a Liquid-liquid Trough, a liquid-liquid Platinum Wilhelmy plate is provided instead. Finally, the Alternate troughs come with 2 Large Platinum Wilhelmy plates, one for each compartment. In a Lite Trough, only paper Wilhelmy plates are included.

Wilhelmy plate rod

Ref. KN 0004

When working with small surface areas, a Wilhelmy platinum rod (diameter 1 mm) can be used as a surface pressure probe.



6. Software

LB Software

Ref. KN 0014

KSV NIMA LB Software for Langmuir film fabrication and characterisation as well as Langmuir-Blodgett film deposition.

Computer with pre-installed LB software | ref. KN 0015

7. Services and other items

Onsite installation and training

Ref. STUP

An installation service for customers purchasing any Langmuir or LB Deposition Trough. The equipment will be set up in your preferred location, tested and demonstrated by a KSV NIMA specialist. Includes installation, aligning and calibration of the instrument and at least one full day of training at the customer premises.

Monolayer starter kit

Ref. KN 0053

Complete starter kit for L & LB measurements, including for example Wilhelmy plates, deposition syringe and other necessary tools. Included in most KSV NIMA troughs as default, can also be ordered separately as a spare set.

7. Other characterization instruments

Platinum Wilhelmy Plates

Please note the following Langmuir and Langmuir-Blodgett film characterization instruments are available from KSV NIMA:

- **Interfacial Shear Rheometer**,
to study monolayer rheological properties
- **MicroBAM Brewster Angle Microscope**,
for monolayer imaging
- **Surface Potential Sensor**,
for monolayer electrical properties characterisation
(also mentioned above as accessory KN 0001)

	Small	Medium	Liquid-Liquid Medium	Large	Liquid-Liquid High Compression	High Compression	Alternate	Roll-to-Roll
Surface area (cm ²)	98	273	269 (197*)	841	580 (423*)	587	586 (x2**)	2330
Trough top inner dimensions (L x W x H mm)	195 x 50 x 4	364 x 75 x 4	364 x 74 x 7 (364 x 54 x 10*)	580 x 145 x 4	784 x 74 x 7 (784 x 54 x 10*)	782 x 75 x 5	782 x 75 x 5 (x2**)	685 x 340 x 4
Maximum compression ratio	5.2	10.8	10.8	18	24.7	24.7	3.9	-
Barrier speed (mm/min)	0.1...270	0.1...270	0.1...270	0.1...270	0.1...270	0.1...270	0.1...270	0.1...270
Balance measuring range (mN/m)	0...300	0...300	0...300	0...300	0...300	0...300	0...300	0...300
Maximum balance load (g)	1	1	1	1	1	1	1	1
Balance resolution (µN/m)	0.03	0.03	0.03	0.03	0.03	0.03	0.03	0.03
Langmuir trough top	•	•	-	•	•	•	-	-
Total subphase volume (mL)	39	109	-	336	406 (212*)	293	-	-
Langmuir-Blodgett trough top	•	•	•	•	-	-	•	•
Total subphase volume (mL)	57	176	450	578	-	-	1400	5430
Dipping well dimensions (L x W x H mm)	20 x 30 x 30	20 x 56 x 60	20 x 54 x 60	20 x 110 x 110	-	-	Half a circle, radius 75; depth 74	300 x 300 x 50
Maximum sample size (T x W x H mm)	3 x 26 x 26 (1 inch)	3 x 52 x 56 (2 inches)	3 x 50 x 56	3 x 106 x 106 (4 inches)	-	-	3 x 30 x 50 (min height 30 mm)	200 (Substrate width)
Dipping speed (mm/min)	0.1...108	0.1...108	0.1...108	0.1...108	-	-	0.1...108	1...100 (Substrate roll speed)
Extraction angle	-	-	-	-	-	-	-	Adjustable, 30-90 degrees with increments
Upright microscopy trough top	•	-	-	-	-	-	-	-
Inverted microscopy trough top	-	•	-	-	-	-	-	-
Ribbon barrier trough top	-	•	-	-	-	-	-	-
Compatible with								
KSV NIMA ISR	-	-	-	-	•	•	-	-
KSV NIMA MicroBAM	-	•	-	•	-	•	•	•
KSV NIMA SPOT	-	•	•	•	-	•	-	•

• : available
 - : not available/not applicable

* The Liquid-Liquid Trough is deeper than a standard trough as this allows for the two liquid phases.

The value in the brackets corresponds to confinement of the lower phase (other value for the upper phase).

** The Alternate-Layer Deposition Trough is made of two separated compartments for creation of two monolayers simultaneously.



Each of these four colours used in the table correspond to one frame.

All trough tops labelled with the same colour can be placed on the same frame, for modularity.

About us

We are Biolin Scientific. A worldwide company making state of the art instruments and smart solutions for scientists. Knowledge is our greatest resource and an essential part of everything we do. In collaboration with leading universities and industries, we solve challenges to simplify the everyday life in the lab. Our customers are the experts in surface science, and we have the tools for them to progress.



Biolin Scientific

[Progress Together]

Biolin Scientific AB

Hängpilsgatan 7, SE-426 77 Västra Frölunda

Phone: +46 31 769 7690 E-mail: info@biolinscientific.com

www.biolinscientific.com